

Series 1500 .375" (9.52mm) Center-to-Center Spacing



Features:

- **Flexible Hi-Temp Thermoplastic Terminal Blocks** – Self-extinguishing types which resist breakage and other damage (conform to UL 94V-0).
- **Terminal Flexibility** – Ideal for surface mount, sub-panel or chassis connections in electronic/electrical circuit applications. One thru 22 terminals. 1500 Series is .375" on centers.
- **Economical Closed-Back Design** – No need for costly insulation strip.
- **Broad Wire Range** – No. 6-32 external twin screws, UL recognized for No. 22AWG to No. 10AWG. Variations include double solder lug, single solder lug, wire wrap, solder pin and printed circuit pin.
- **UL/CSA Electrical Ratings** – UL 30A/1100V RMS (1/3 breakdown voltage), CSA rating 15A/300V.
- **Recognition and Listing** – Various terminal types are UL recognized and CSA certified.

Series 1500 Variations

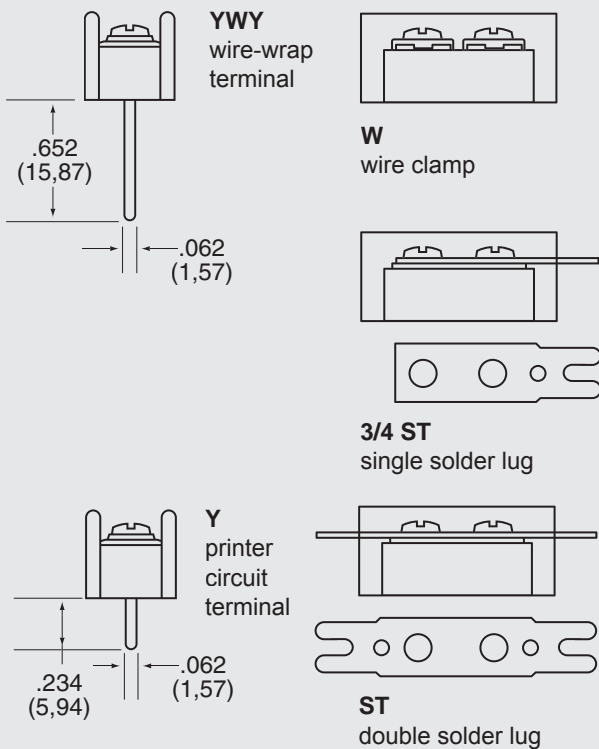

INTERNAL TERMINAL DESIGNATIONS

- 1500-Y** printed circuit board design with .062" x .031" solderable tin-plated pin
- 1500-YWY** feed-thru wire wrap

EXTERNAL TERMINAL DESIGNATIONS

- 1500** screw terminal with No. 6-32 plated steel* screw accepting up to No. 10AWG wire
- 1500-ST** solderable tin-plated double solder tab
- 1500-3/4ST** solderable tin-plated single solder tab
- 1500-W** wire clamp captivated to a No. 6-32 plated steel screw

* Other materials available – contact factory or your local representative for additional information.

UL Recognized under the Components Program of Underwriters Laboratories, Inc. Standard 1059, Guide No. XCFR2, File No. E62557.

CSA Guide No. 22.2 No. 158, Report No. LR39186-1. COMPLIES WITH IEC 947-7-1

Series 1500 Dimensions

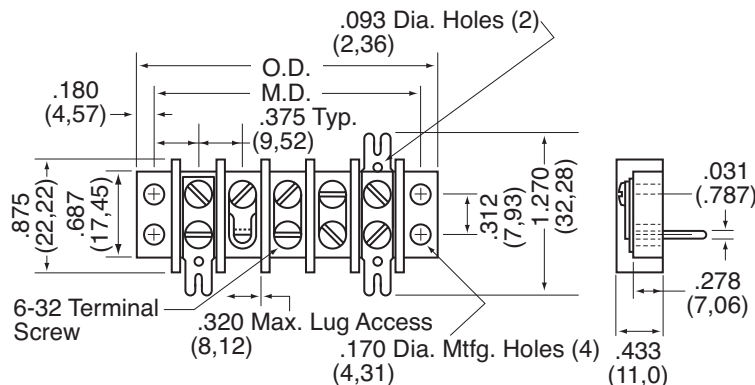

Dual Row

BARRIER STYLE

Specifications:

Center-to-Center Spacing: .375" (9.52mm)

Wire Range: Up to No. 12AWG (CSA requires use of lugs on wire larger than No. 16AWG.)

No. of Terminals: 1 thru 22

Voltage Rating:

CSA – 300V

UL – 150V – General Industrial

250V – Commercial Appliance

300V – Limited Energy Industrial

Tightening Torque: Wire Clamp and Wire Binding Screw 12 in.-lbs.

Current Rating: UL: 20 amps CSA: 15 amps

Housing:

Material Polyphenylene Oxide

Continuous Use

Temp. (UL Index) 110°C (230°F)

Flammability Rating 94V-0

Water Absorption

(24 hrs. % wt. gain) .06%

Chemical Resistance Resistant to inorganic bases and acids. For organic substances contact factory for specific resistance.

Breakdown Voltage:

Terminal - Terminal 3,400V Typ.

Terminal - Ground 7,300V Typ.

Note: Specifications contained herein are subject to change without notice.

PC BOARD DRILLING DIMENSIONS

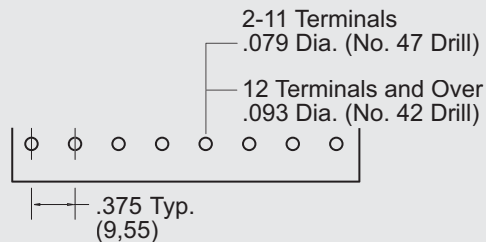

How to Order

1500 Series terminal blocks are ordered by listing a composite number made up of the model designation in which the last two digits indicate the number of poles required for the application. Example: A 1500 10-terminal block (3/8" centers) becomes stock number 1510.

Suffixes are used as follows:

ST denotes double solder lug

3/4ST denotes single solder lug

Y denotes printed circuit pin

YWY feed-thru wire wrap

W wire clamp

The 1510 described above, with double solder lug mounting on 3/8" centers thus converts to stock number 1510-ST. To specify quick-connect terminals, simply add the style number required. (See accessories.) May be purchased factory-assembled or as customer-installed accessory.

Number of Terminals	Mounting Dimensions		Overall Dimensions	
	Inches	Metric (mm)	Inches	Metric (mm)
1	.750	19.05	1.030	26.16
2	1.125	28.57	1.405	35.68
3	1.500	38.10	1.780	45.21
4	1.875	47.62	2.155	54.73
5	2.250	57.15	2.530	64.26
6	2.625	66.67	2.905	73.78
7	3.000	76.20	3.280	83.31
8	3.375	85.72	3.655	92.83
9	3.750	95.25	4.030	102.36
10	4.125	104.77	4.405	111.88
11	4.500	114.30	4.780	121.41
12	4.875	123.82	5.155	130.93
13	5.250	133.35	5.530	140.46
14	5.625	142.87	5.905	149.98
15	6.000	152.40	6.280	159.51
16	6.375	161.92	6.655	169.03
17	6.750	171.45	7.030	178.56
18	7.125	180.97	7.405	188.08
19	7.500	190.05	7.780	197.61
20	7.875	200.02	8.155	207.13
21	8.250	209.55	8.530	216.66
22	8.625	219.07	8.905	226.18

Dimensions Shown are ± 0.030 "

Series 1500/2000 Accessories

QUICK-CONNECT TERMINALS

1500/2000 – Available with .187" x .202" quick-connect tabs for 1500 series; .250" x .032" for 2000 series. Nine styles . . . tin-plated brass tabs held in place by terminal screws. Up to six terminations per pole. To order, specify:

1500 Series: Part No. TB11-19

2000 Series: Part No. TB31-39

Last digit of part number corresponds to previous style numbers.

Dual Row

BARRIER STYLE

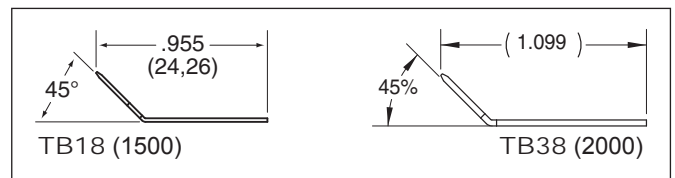
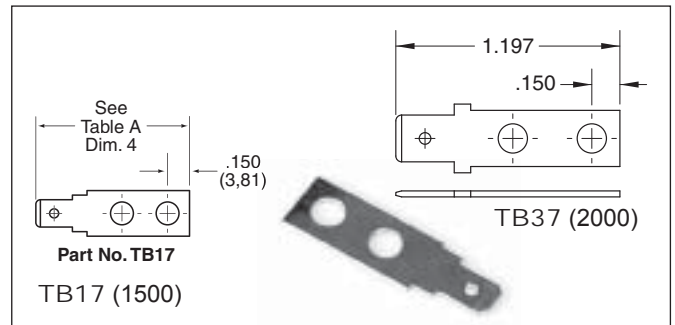
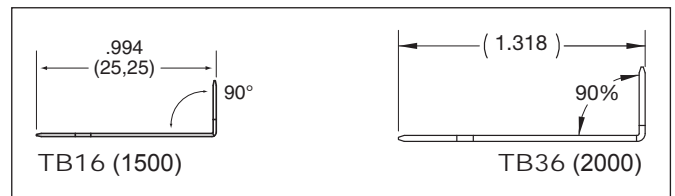
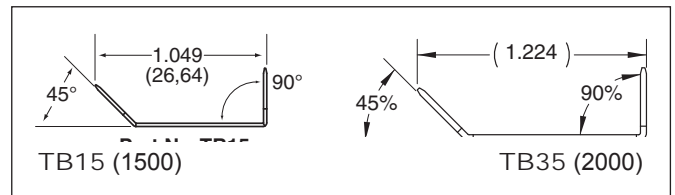
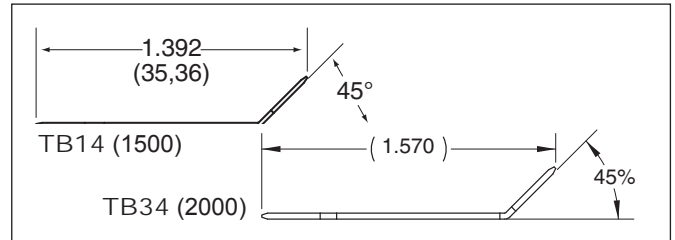
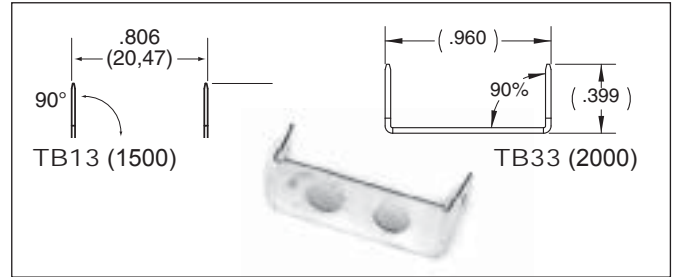
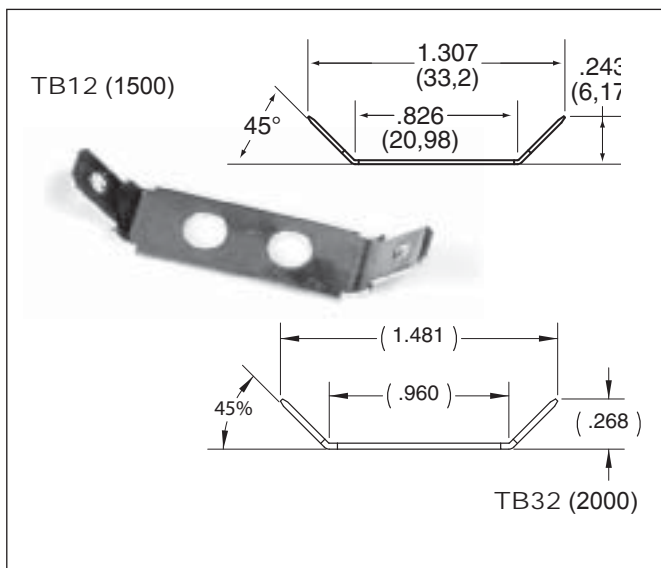
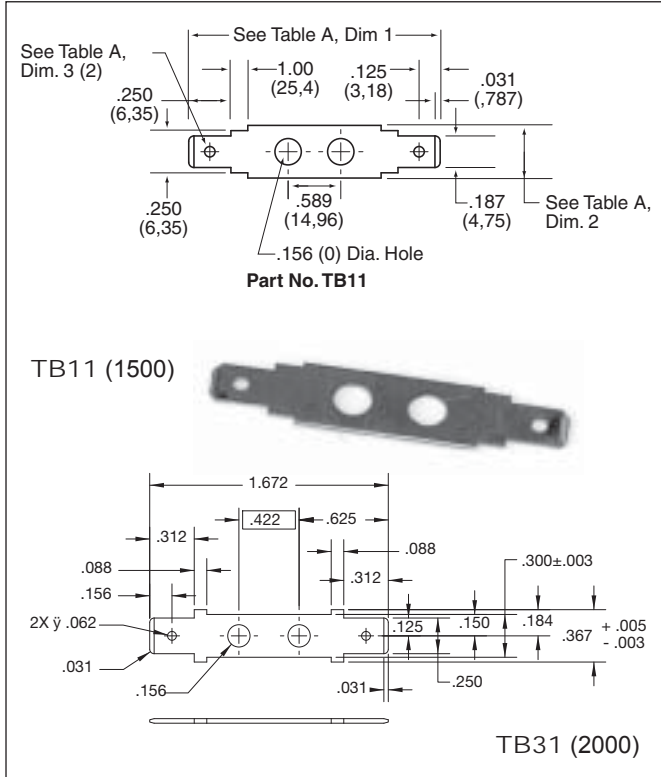



MARKING STRIPS

1500/2000 Pre-punched black fiber . . . mounts under block.
May be imprinted to customer specifications.

To order, specify:

1500 Series – Part No. 247A10-1 thru 22

2000 Series – Part No. 247A11-1 thru 22

WIRE CLAMP

1500/2000 – Wire clamp captivated to No. 6-32 screw eliminates need for lugs.

1500 Series – Part No. 058525700

2000 Series – Part No. 058526700

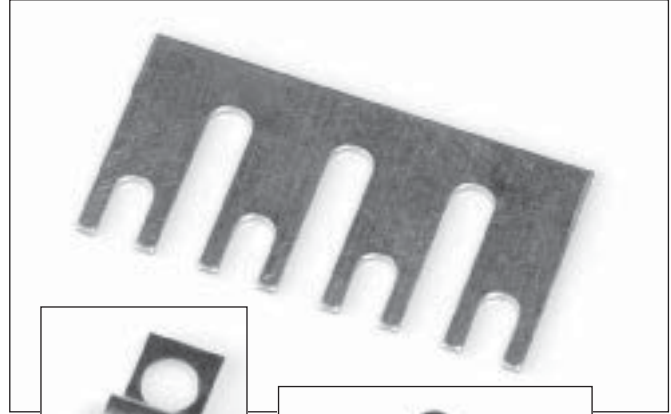

Part No.
68240100

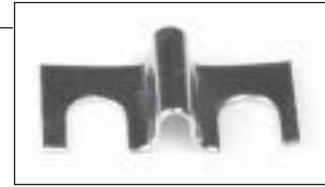

Part No. 68245100

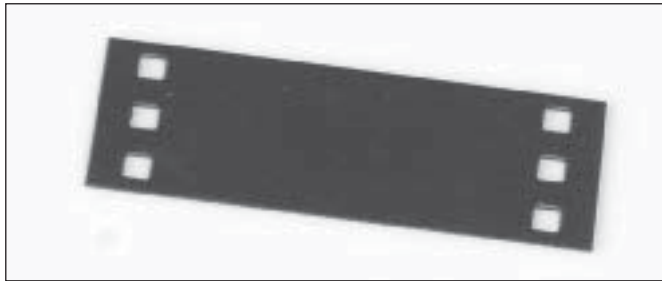

COVERS

1500/2000 – Rigid .030" thick self-extinguishing vinyl.
Complete with spring clips for attaching to mounting positions.

To order, specify:

1500 Series – Part No. 247B24-1 thru 26 terminals

2000 Series – Part No. 247B25-1 thru 26 terminals

TERMINAL BLOCK JUMPERS

1500 – Jumper is constructed of plated brass. "Rooster comb" design permits connections of two to 10 poles.

To order, specify: Part No. 278-A11 (plus no. of poles)

Example: 278A11-10

Part No. 68240100 (Holes) or 68245100 (slots)
(2-pole jumper for 1500 only)

2000 – Plated brass in two styles. Types 267A28 is designed to jump two adjacent terminals as it is channeled to cross over the barrier top. "Rooster comb" design of Type 267A42 permits connections of two to 18 poles.

To order, specify: Part No. 267A42 (plus no. of poles)

Example: 267A42-18

Series 2000 .4375" (11.1mm) Center-to-Center Spacing

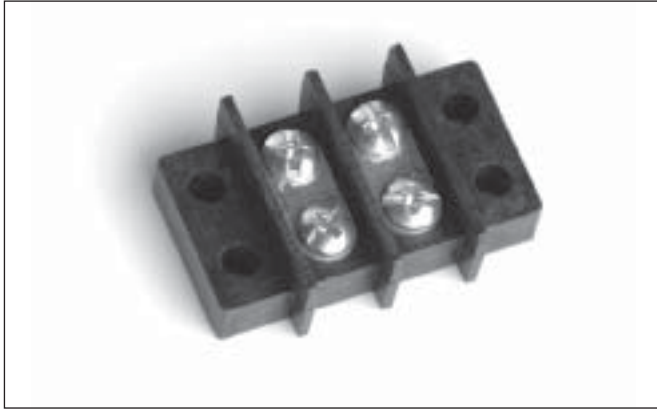

Features:

- **Flexible Hi-Temp Thermoplastic Terminal Blocks** – Self-extinguishing types which resist breakage and other damage (conform to UL94V-0).
- **Terminal Flexibility** – Ideal for surface mount, sub-panel or chassis connections in electronic/electrical circuit applications. One thru 26 terminals.
- **Economical Closed-Back Design** – No need for costly insulation strip.
- **Broad Wire Range** – No. 6-32 external twin screws, UL recognized for No. 22AWG to No. 10AWG. Variations include double solder lug, single solder lug, wire wrap, solder pin and printed circuit pin.
- **UL/CSA Electrical Ratings** – UL 30A/1100V RMS (1/3 breakdown voltage), CSA rating: 20A/300.
- **Recognition and Listing** – Various terminal types are UL recognized and CSA certified.

Series 2000 Variations

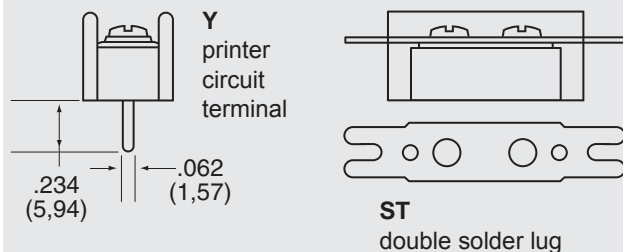
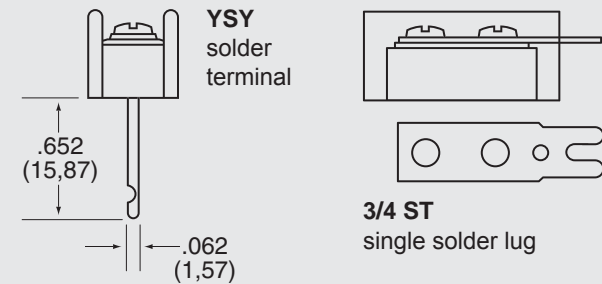
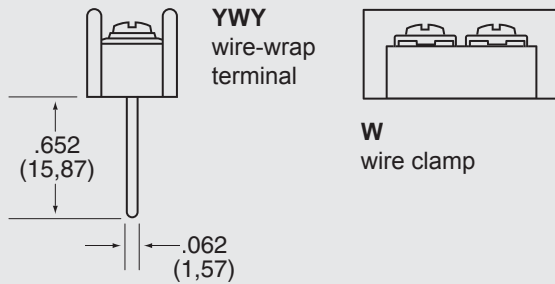

INTERNAL TERMINAL DESIGNATIONS

2000-Y	printed circuit board design with .062" x .031" solderable tin-plated pin
2000-YSY	solder pin
2000-YWY	wire wrap

EXTERNAL TERMINAL DESIGNATIONS

2000	screw terminal with No. 6-32 plated steel* screw accepting up to No. 10AWG wire
2000-ST	solderable tin-plated double solder tab
2000-3/4ST	solderable tin-plated single solder tab
2000-W	wire clamp captivated to a No. 6-32 plated steel screw

* Other materials available – contact factory or your local representative for additional information.

 Recognized under the Components Program of Underwriters Laboratories, Inc. Standard 1059, Guide No. XCFR2, File No. E62557.

 Guide No. 22.2 No. 158, Report No. LR39186-1. COMPLIES WITH IEC 947-7-1

Series 2000 Dimensions

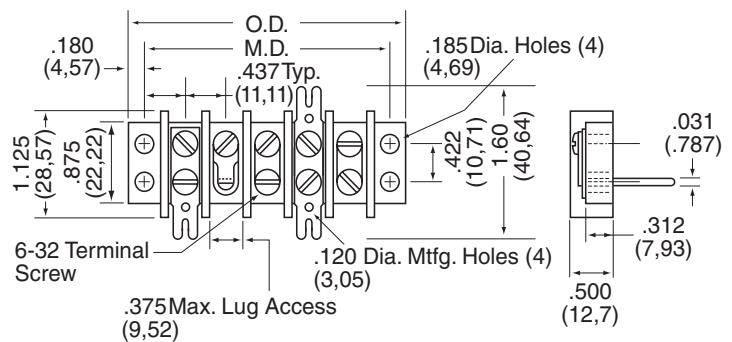

Dual Row

BARRIER STYLE

Specifications:

Center-to-Center Spacing: .4375" (11.11mm)

Wire Range: Up to No. 10AWG (CSA requires use of lugs on wire larger than No. 16AWG.)

No. of Terminals: 1 thru 26

Voltage Rating:

CSA – 300V

UL – 150V – General Industrial

250V – Commercial Appliance

300V – Limited Energy Industrial

Tightening Torque: Wire Clamp and Wire Binding Screw 12 in.-lbs.

Current Rating: UL: 30 amps CSA: 20 amps

Housing:

Material Polyphenylene Oxide

Continuous Use

Temp. (UL Index) 110°C (230°F)

Flammability Rating 94V-0

Water Absorption

(24 hrs. % wt. gain) .06%

Chemical Resistance Resistant to inorganic bases and acids. For organic substances contact factory for specific resistance.

Breakdown Voltage:

Terminal - Terminal 4,400V Typ.

Terminal - Ground 7,700V Typ.

Note: Specifications contained herein are subject to change without notice

PC BOARD DRILLING DIMENSIONS

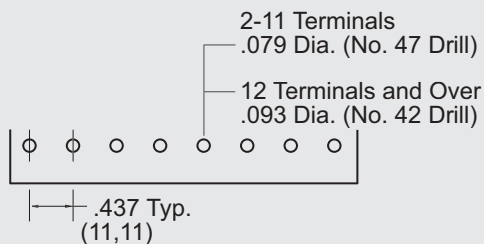

How to Order

2000 Series terminal blocks are ordered by listing a composite number made up of the model designation in which the last two digits indicate the number of poles required for the application. Example: A 2000 10-terminal block becomes stock number 2010.

Suffixes are used as follows:

ST denotes double solder lug

3/4ST denotes single solder lug

Y denotes printed circuit pin

YSY solder pin

YWY wire wrap

W wire clamp

The 2010 described above, with double solder lug mounting on 7/16" centers thus converts to stock number 2010-ST. To specify quick-connect terminals, simply add the style number required. (See accessories.) May be purchased factory-assembled or as customer-installed accessory.

Number of Terminals	Mounting Dimensions		Overall Dimensions	
	Inches	Metric (mm)	Inches	Metric (mm)
1	.875	22.22	1.235	31.36
2	1.312	33.33	1.672	42.48
3	1.750	44.45	2.110	53.59
4	2.187	55.56	2.547	64.70
5	2.625	66.67	2.985	75.81
6	3.062	77.78	3.422	86.93
7	3.500	88.90	3.860	98.04
8	3.937	100.01	4.297	109.15
9	4.375	111.12	4.735	120.26
10	4.812	122.23	5.172	131.38
11	5.250	133.35	5.610	142.49
12	5.687	144.46	6.047	153.60
13	6.125	155.57	6.485	164.71
14	6.562	166.68	6.922	175.83
15	7.000	177.80	7.360	186.94
16	7.437	188.91	7.797	198.05
17	7.875	200.02	8.235	209.16
18	8.312	211.13	8.672	220.28
19	8.750	222.25	9.110	231.39
20	9.187	233.36	9.547	242.50
21	9.625	244.47	9.985	253.61
22	10.062	255.58	10.422	264.73
23	10.500	266.70	10.860	275.84
24	10.938	277.83	11.299	286.77
25	11.376	288.95	11.736	298.09
26	11.814	300.08	12.174	309.22

Dimensions Shown are ± 0.030"

Series 1500/2000 Accessories

QUICK-CONNECT TERMINALS

1500/2000 – Available with .187" x .202" quick-connect tabs for 1500 series; .250" x .032" for 2000 series. Nine styles . . . tin-plated brass tabs held in place by terminal screws. Up to six terminations per pole. To order, specify:

1500 Series: Part No. TB11-19

2000 Series: Part No. TB31-39

Last digit of part number corresponds to previous style numbers.

Dual Row

BARRIER STYLE

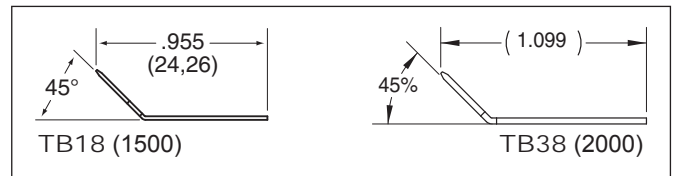
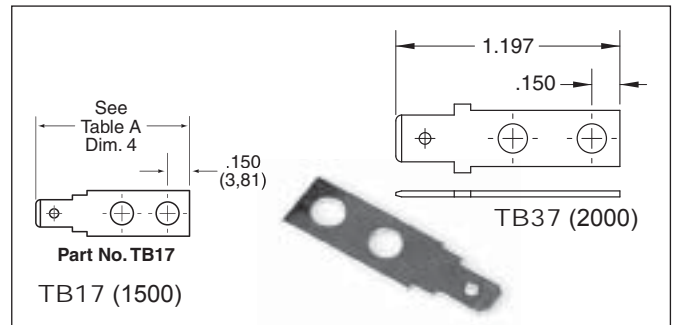
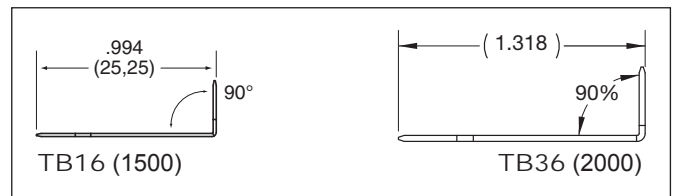
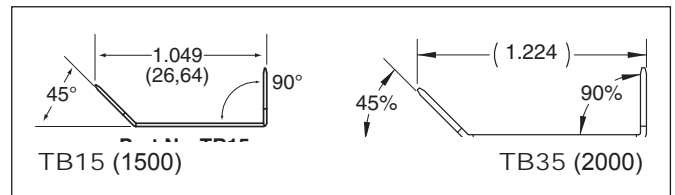
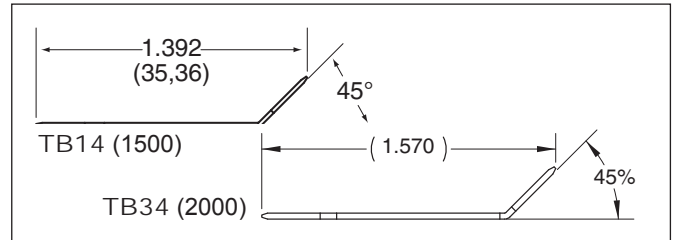
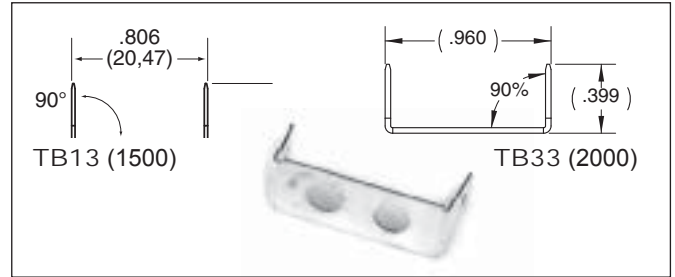
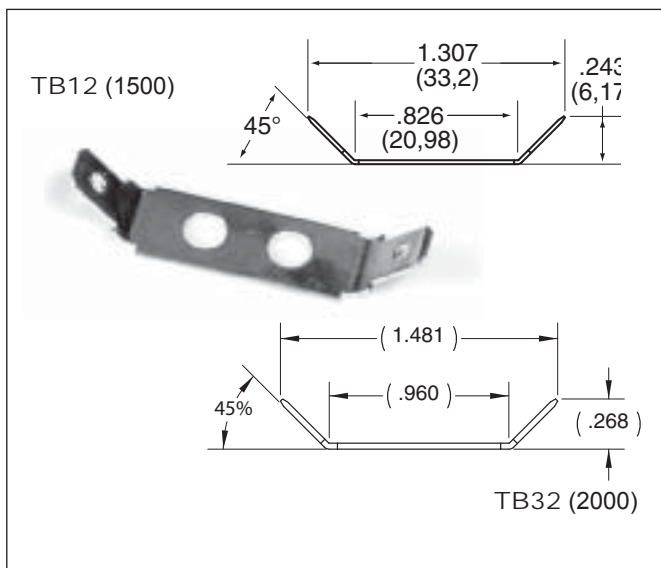
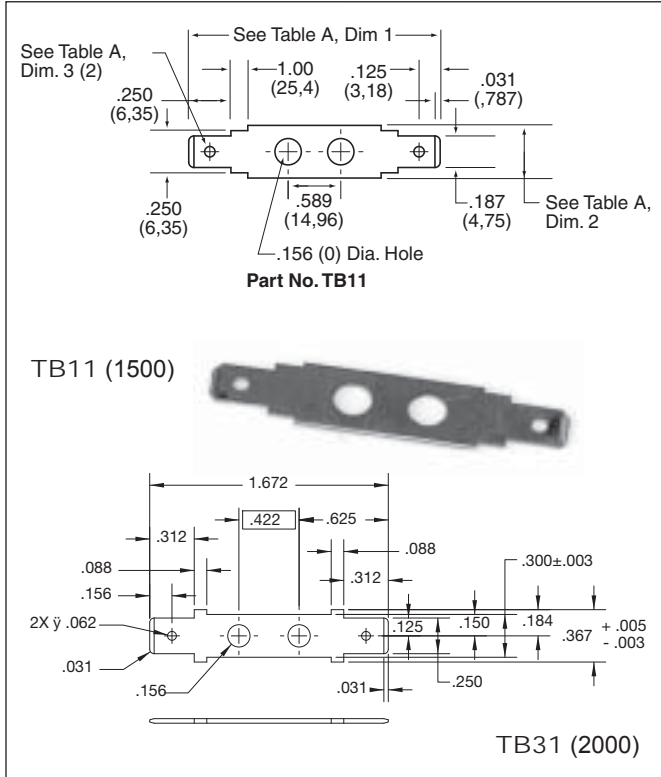

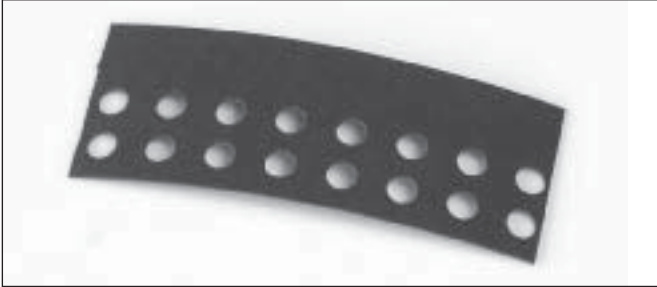

MARKING STRIPS

1500/2000 Pre-punched black fiber . . . mounts under block.
May be imprinted to customer specifications.

To order, specify:

1500 Series – Part No. 247A10-1 thru 22

2000 Series – Part No. 247A11-1 thru 22

WIRE CLAMP

1500/2000 – Wire clamp captivated to No. 6-32 screw eliminates need for lugs.

1500 Series – Part No. 058525700

2000 Series – Part No. 058526700

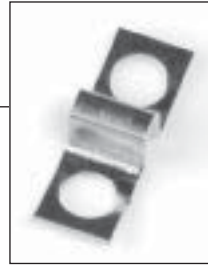
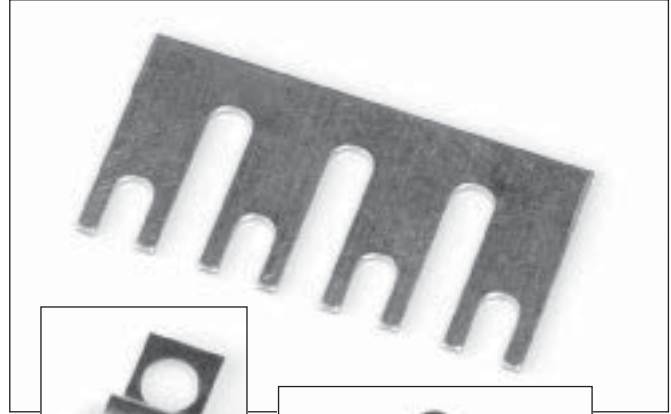

Part No.
68240100

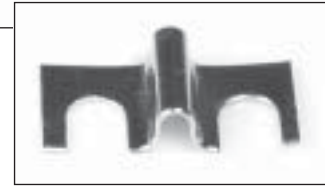

Part No. 68245100

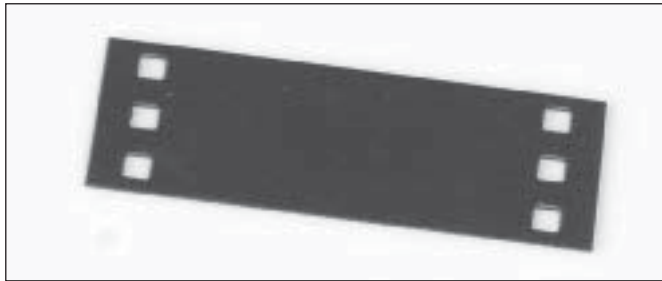

COVERS

1500/2000 – Rigid .030" thick self-extinguishing vinyl.
Complete with spring clips for attaching to mounting positions.

To order, specify:

1500 Series – Part No. 247B24-1 thru 26 terminals

2000 Series – Part No. 247B25-1 thru 26 terminals

TERMINAL BLOCK JUMPERS

1500 – Jumper is constructed of plated brass. "Rooster comb" design permits connections of two to 10 poles.

To order, specify: Part No. 278-A11 (plus no. of poles)

Example: 278A11-10

Part No. 68240100 (Holes) or 68245100 (slots)
(2-pole jumper for 1500 only)

2000 – Plated brass in two styles. Types 267A28 is designed to jump two adjacent terminals as it is channeled to cross over the barrier top. "Rooster comb" design of Type 267A42 permits connections of two to 18 poles.

To order, specify: Part No. 267A42 (plus no. of poles)

Example: 267A42-18